

Embedded Systems

4. Programming Paradigms

© Lothar Thiele

Computer Engineering and Networks Laboratory



Where we are ...

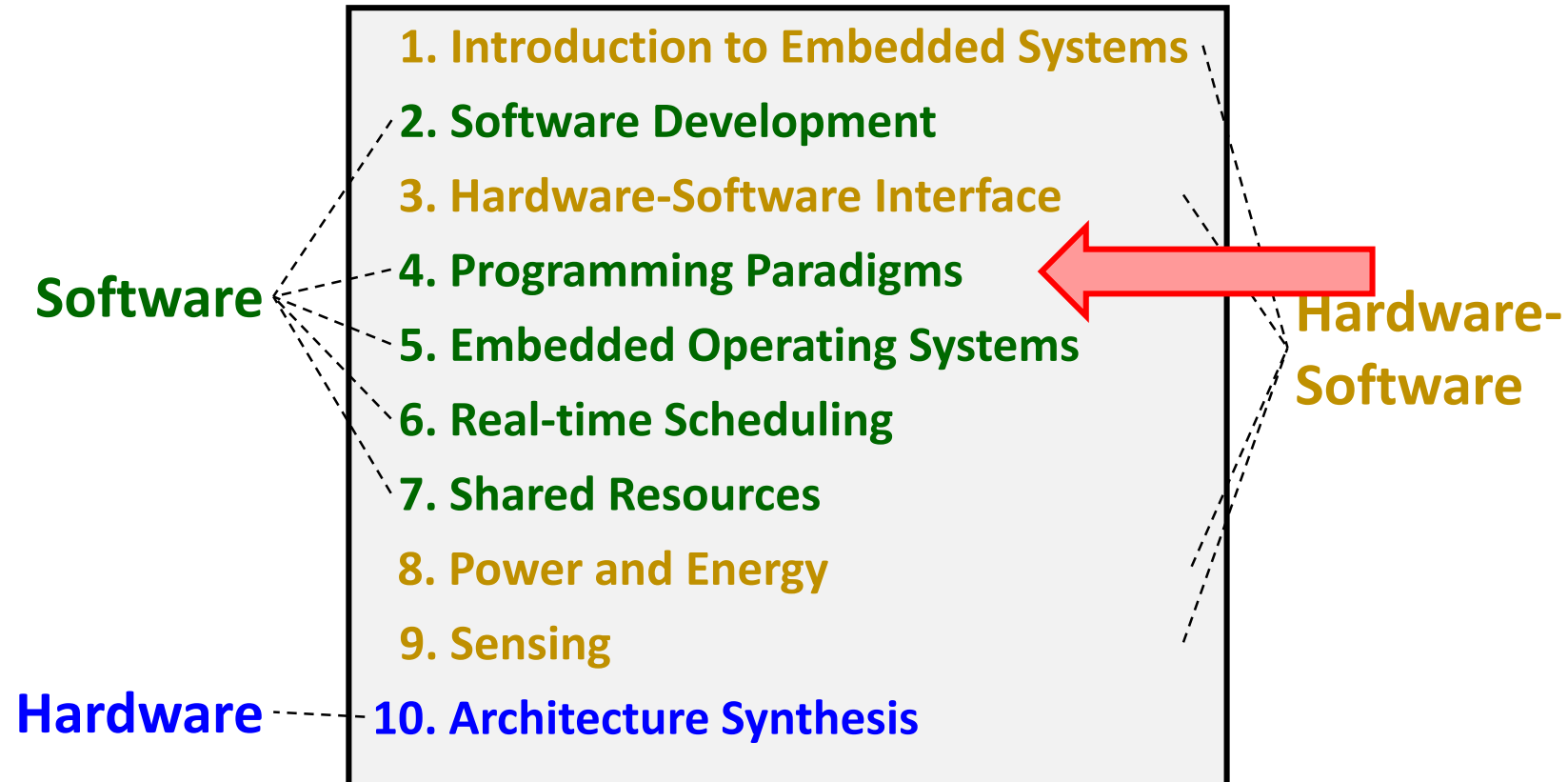

Reactive Systems and Timing

Timing Guarantees

- *Hard real-time systems* can be often found in *safety-critical applications*. They need to provide the result of a computation within a fixed time bound.
- *Typical application domains*:
 - avionics, automotive, train systems, automatic control including robotics, manufacturing, media content production

sideairbag in car,
reaction after event in <10 mSec



Free stream air velocity

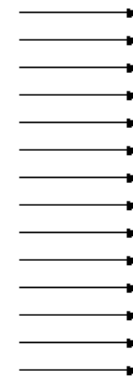

wing vibration of airplane,
sensing every 5 ms

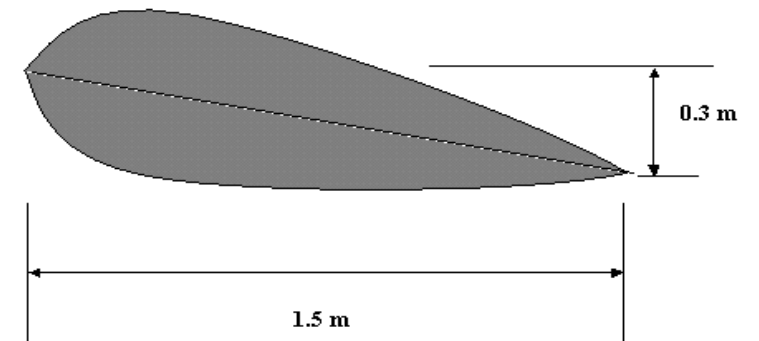

Simple Real-Time Control System

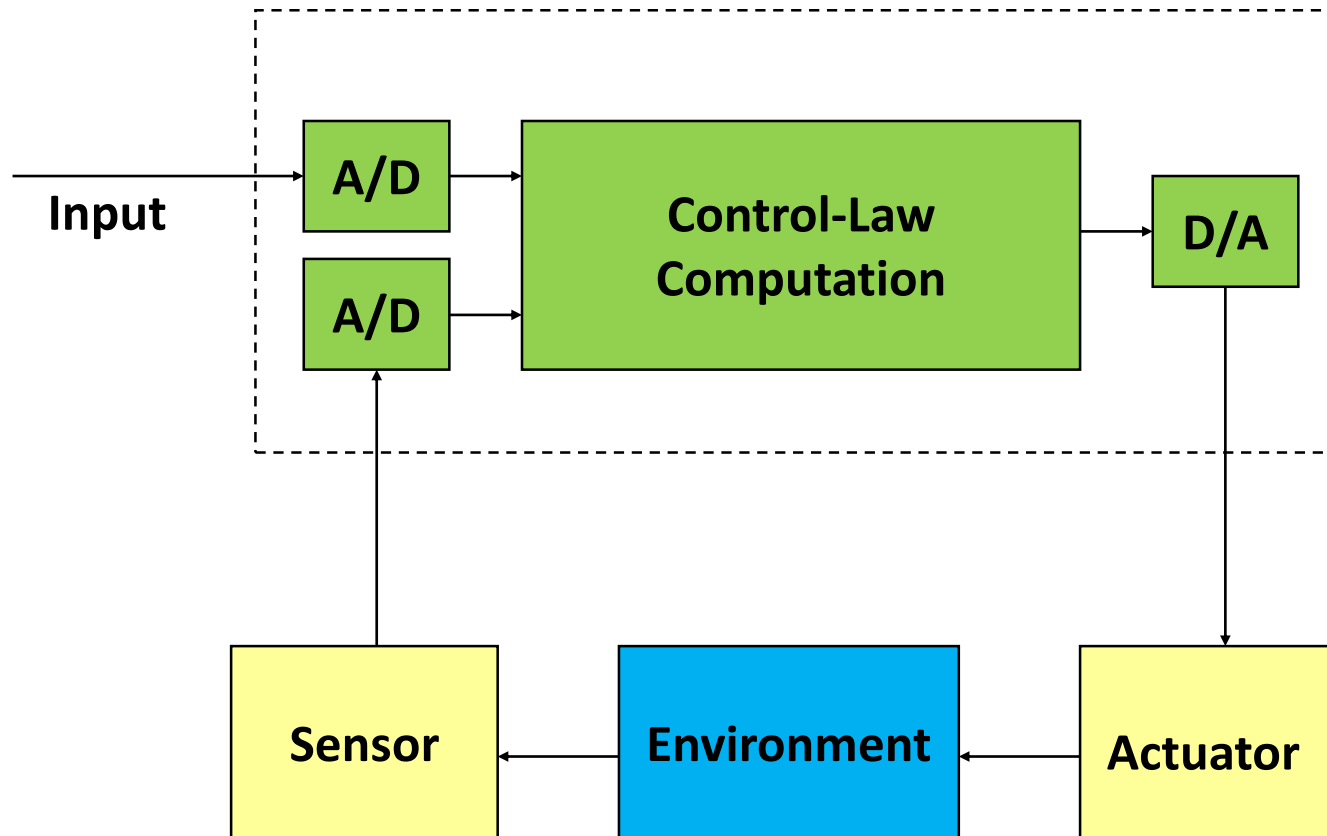

Real-Time Systems

In many *cyber-physical systems (CPSs)*, correct timing is a matter of *correctness*, not performance: *an answer arriving too late is consider to be an error.*

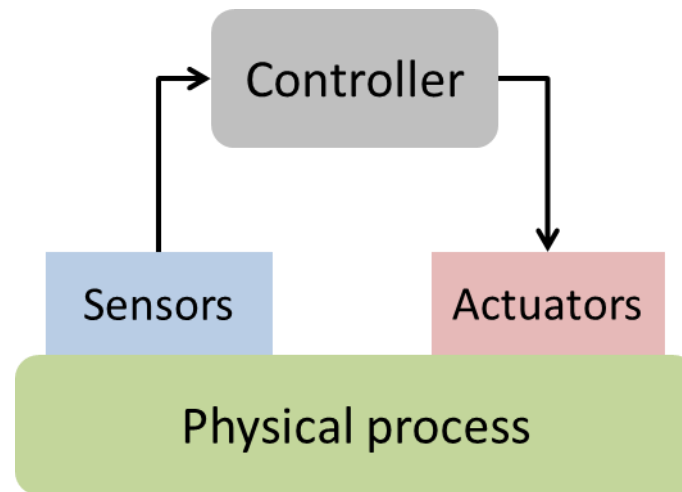

Real-Time Systems

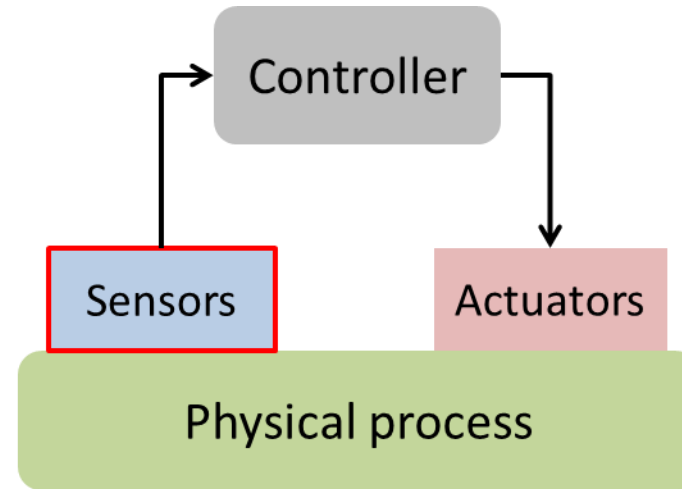

Real-Time Systems

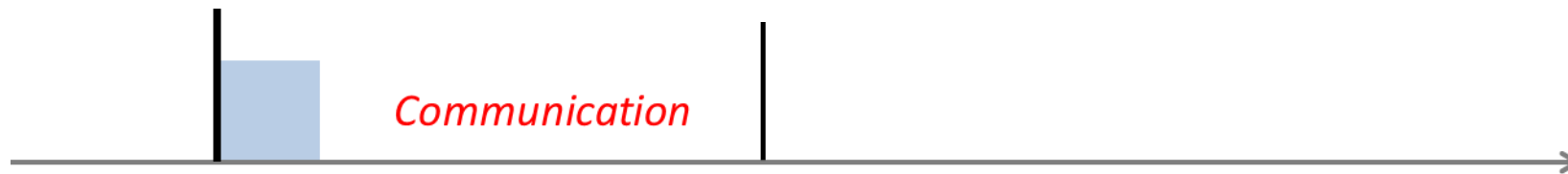
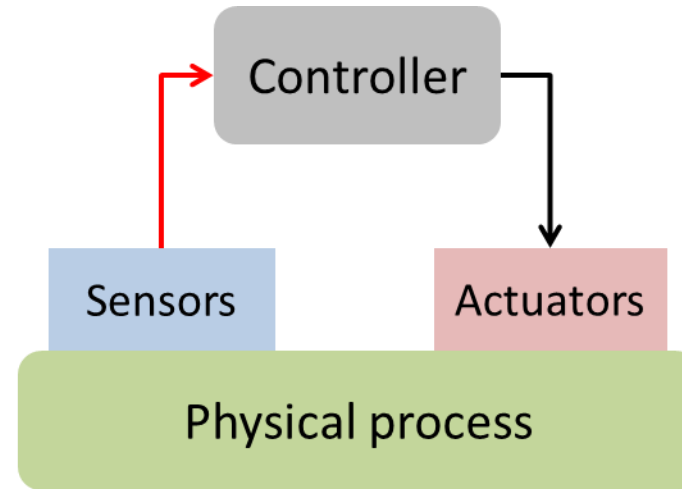

Real-Time Systems

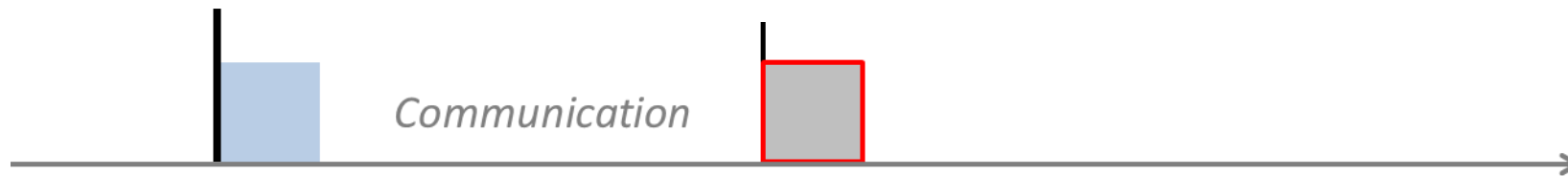
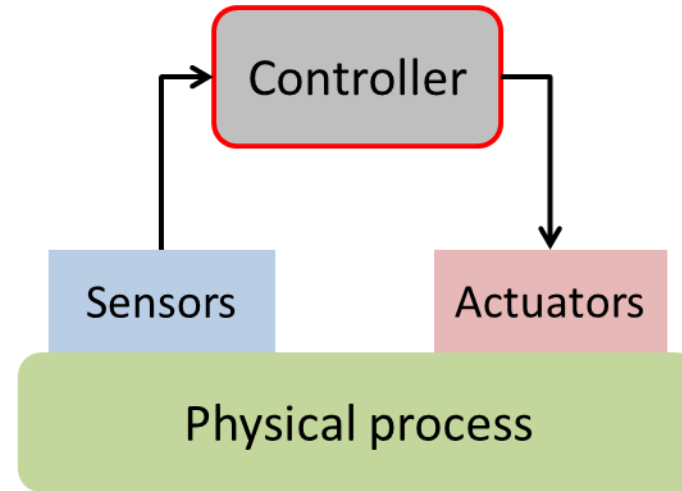

Real-Time Systems

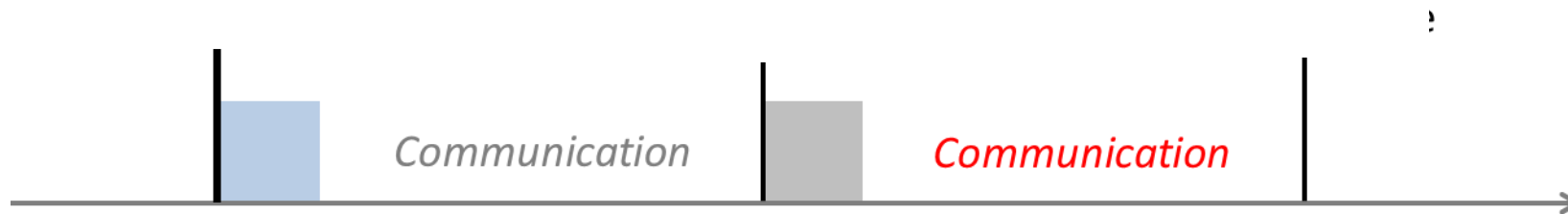
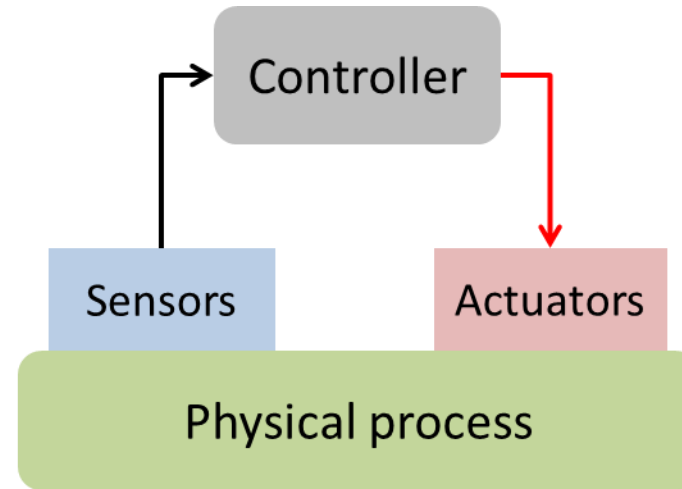

Real-Time Systems

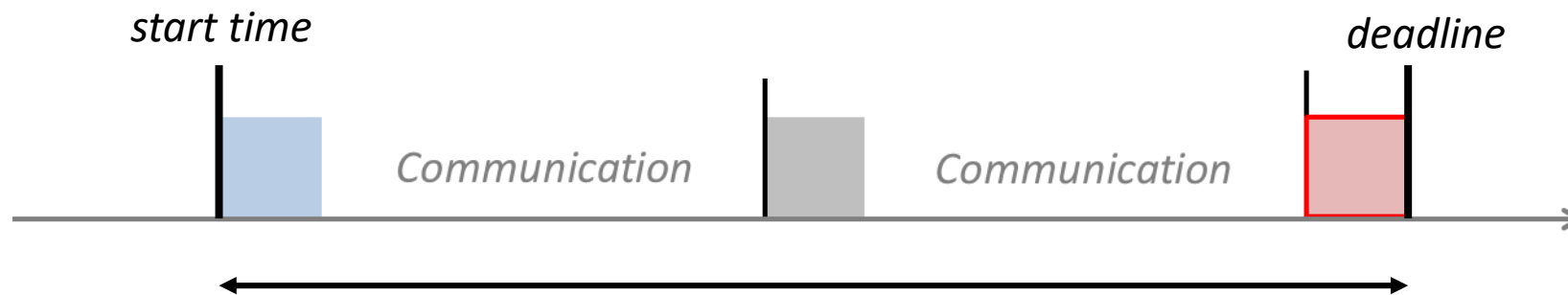
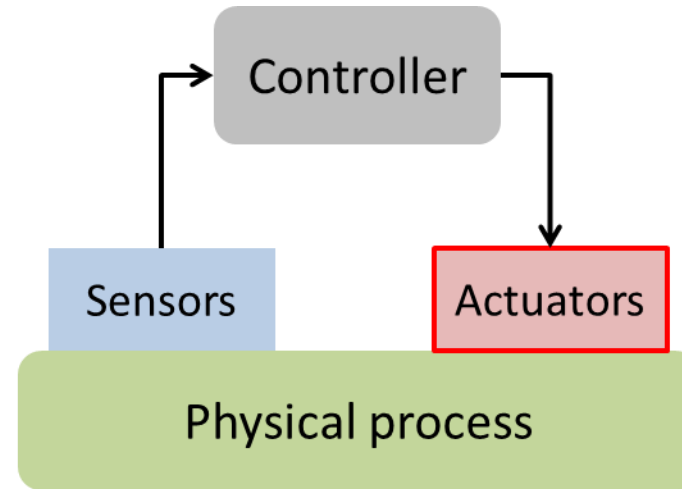

Real-Time Systems

- *Embedded controllers* are often expected to *finish the processing* of data and events reliably *within defined time bounds*. Such a processing may involve sequences of computations and communications.
- Essential for the analysis and design of a real-time system: *Upper bounds on the execution times* of all tasks are statically known. This also includes the communication of information via a wired or wireless connection.
 - This value is commonly called the *Worst-Case Execution Time* (WCET).
 - Analogously, one can define the lower bound on the execution time, the *Best-Case Execution Time* (BCET).

Distribution of Execution Times

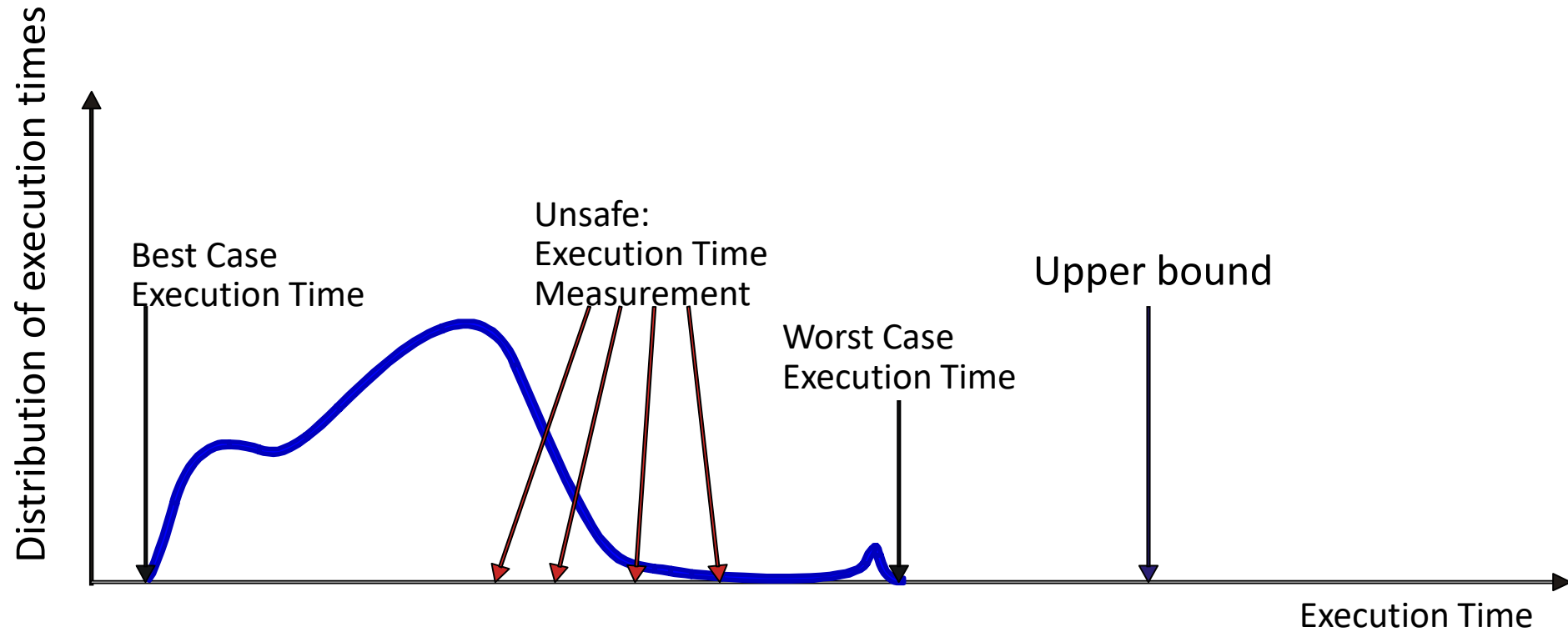

Modern Hardware Features

- Modern processors *increase the average performance* (execution of tasks) by using *caches, pipelines, branch prediction*, and *speculation* techniques, for example.
- *These features make the computation of the WCET very difficult*: The execution times of single instructions vary widely.
- The microarchitecture has a large *time-varying internal state* that is changed by the execution of instructions and that influences the execution times of instructions.
 - *Best case* - everything goes smoothly: no cache miss, operands ready, needed resources free, branch correctly predicted.
 - *Worst case* - everything goes wrong: all loads miss the cache, resources needed are occupied, operands are not ready.
 - *The span between the best case and worst case may be several hundred cycles.*

Determine the WCET

Complexity of determining the WCET of tasks:

- In the general case, it is even *undecidable* whether a finite bound exists.
- For *restricted classes of programs* it is possible, in principle. Computing accurate bounds is *simple for „old“ architectures*, but very *complex for new architectures* with pipelines, caches, interrupts, and virtual memory, for example.

Analytic (formal) approaches exist for hardware and software.

- In case of software, it requires the *analysis of the program flow* and the *analysis of the hardware* (microarchitecture). Both are combined in a complex analysis flow, see for example www.absint.de.
- *For the rest of the lecture, we assume that reliable bounds on the WCET are available*, for example by means of exhaustive measurements or simulations, or by analytic formal analysis.

Different Programming Paradigms

Why Multiple Tasks on one Embedded Device?

- The concept of *concurrent tasks* reflects our intuition about the *functionality of embedded systems*.
- Tasks help us *manage the complexity of concurrent activities* as happening in the system environment:
 - *Input data* arrive from various *sensors* and input devices.
 - These input streams may have different data rates like in multimedia processing, systems with multiple sensors, automatic control of robots
 - The system may also receive *asynchronous (sporadic) input events*.
 - These input event may arrive from user interfaces, from sensors, or from communication interfaces, for example.

Example: Engine Control

Typical Tasks:

- spark control (actuation)
- crankshaft sensing
- fuel/air mixture (actuation)
- oxygen sensor
- control algorithm (computation)

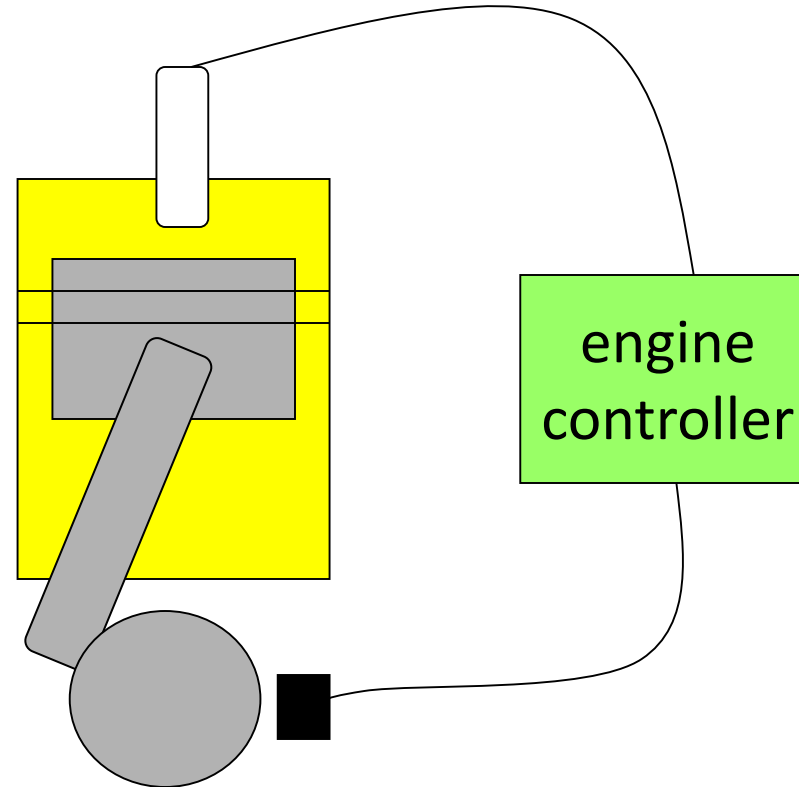

Overview

- There are many *structured ways of programming an embedded system*.
- In this lecture, only the main principles will be covered:
 - *time triggered approaches*
 - periodic
 - cyclic executive
 - generic time-triggered scheduler
 - *event triggered approaches*
 - non-preemptive
 - preemptive – stack policy
 - preemptive – cooperative scheduling
 - preemptive - multitasking

Time-Triggered Systems

Pure time-triggered model:

- *no interrupts* are allowed, except by timers
- the *schedule* of tasks is *computed off-line* and therefore, complex sophisticated algorithms can be used
- the scheduling at run-time is fixed and therefore, it is *deterministic*
- the interaction with environment happens through *polling*

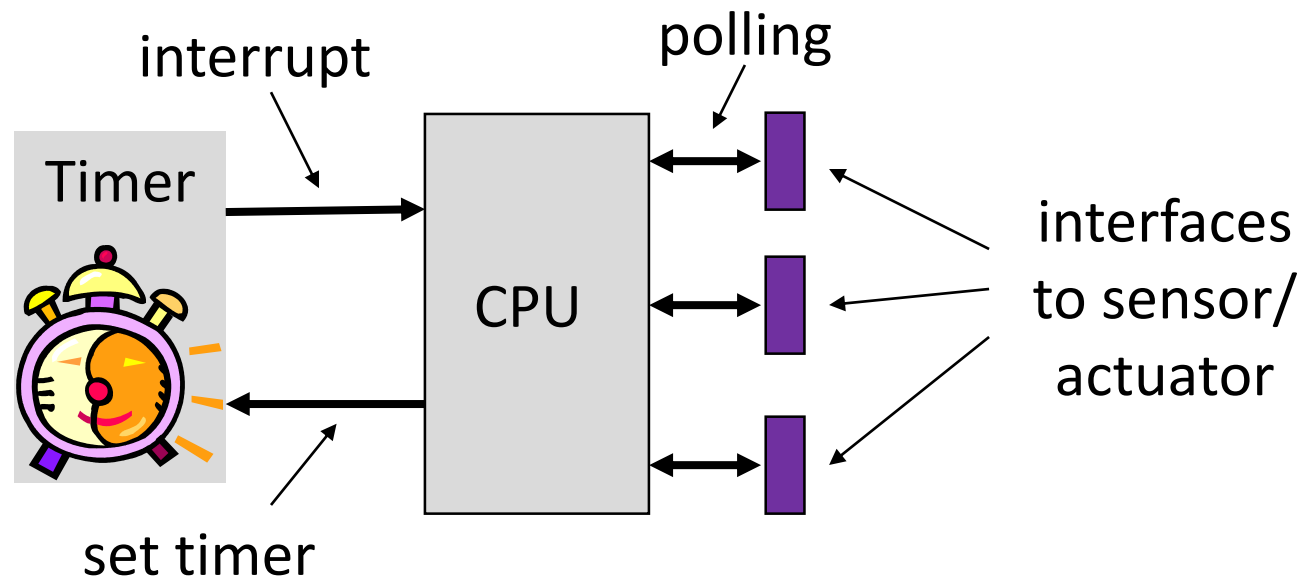

Simple Periodic TT Scheduler

- A *timer interrupts regularly* with period P .
- All tasks have *same period* P .

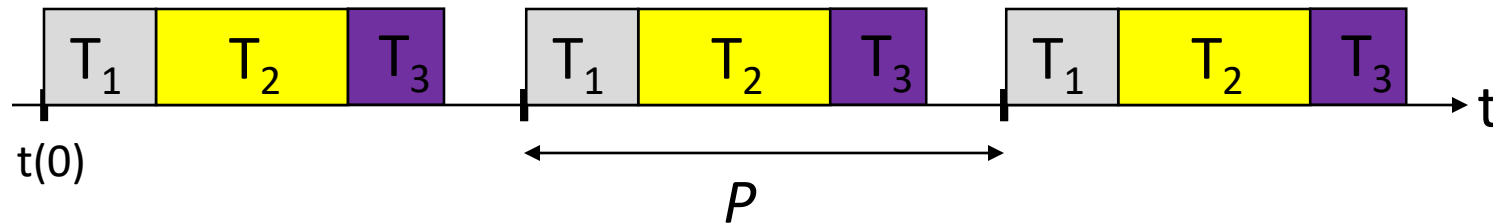

- *Properties:*
 - later tasks, for example T_2 and T_3 , have unpredictable starting times
 - the communication between tasks or the use of common resources is safe, as there is a static ordering of tasks, for example T_2 starts after finishing T_1
 - as a necessary precondition, the sum of WCETs of all tasks within a period is bounded by the period P :

$$\sum_{(k)} WCET(T_k) < P$$

Simple Periodic Time-Triggered Scheduler

main:

```
determine table of tasks (k, T(k)), for k=0,1,...,m-1;  
i=0; set the timer to expire at initial phase t(0);  
while (true) sleep();
```

usually done offline

set CPU to low power mode;
processing starts again after interrupt

Timer Interrupt:

```
i=i+1;  
set the timer to expire at i*P + t(0);  
for (k=0,...,m-1){ execute task T(k); }  
return;
```

for example using a function pointer in C;
task(= function) returns after finishing.

k	T(k)
0	T ₁
1	T ₂
2	T ₃
3	T ₄
4	T ₅

m=5

Time-Triggered Cyclic Executive Scheduler

- Suppose now, that *tasks may have different periods*.
- To accommodate this situation, the *period P is partitioned into frames of length f* .

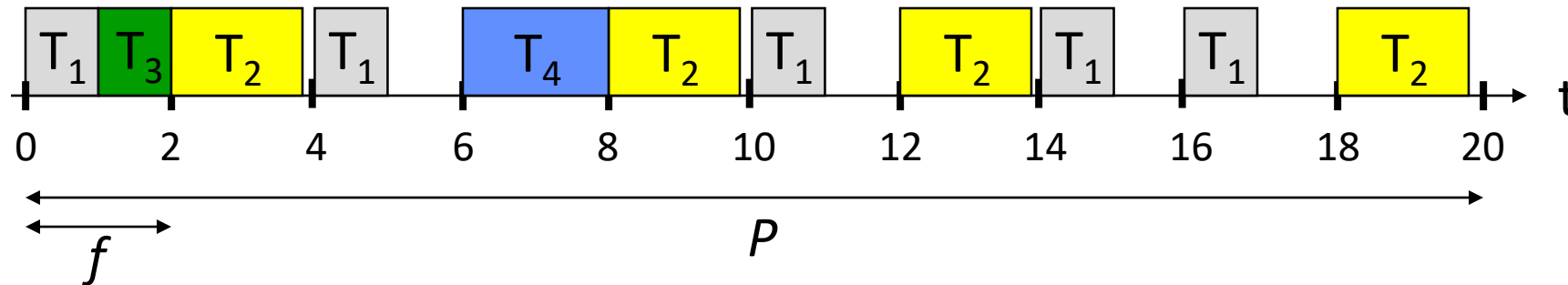

- We have a *problem* to determine a feasible schedule, if there are *tasks with a long execution time*.
 - long tasks could be partitioned into a sequence of short sub-tasks
 - but this is tedious and error-prone process, as the local state of the task must be extracted and stored globally

Time-Triggered Cyclic Executive Scheduling

- *Examples for periodic tasks:* sensory data acquisition, control loops, action planning and system monitoring.
- When a control application consists of several concurrent periodic tasks with individual timing constraints, *the schedule has to guarantee* that each periodic instance is *regularly activated* at its proper rate and is *completed within its deadline*.
- *Definitions:*
 - Γ : denotes the set of all periodic tasks
 - τ_i : denotes a periodic task
 - $\tau_{i,j}$: denotes the j th instance of task i
 - $r_{i,j}, d_{i,j}$: denote the release time and absolute deadline of the j th instance of task i
 - Φ_i : phase of task i (release time of its first instance)
 - D_i : relative deadline of task i

Time-Triggered Cyclic Executive Scheduling

- *Example* of a single periodic task τ_i :

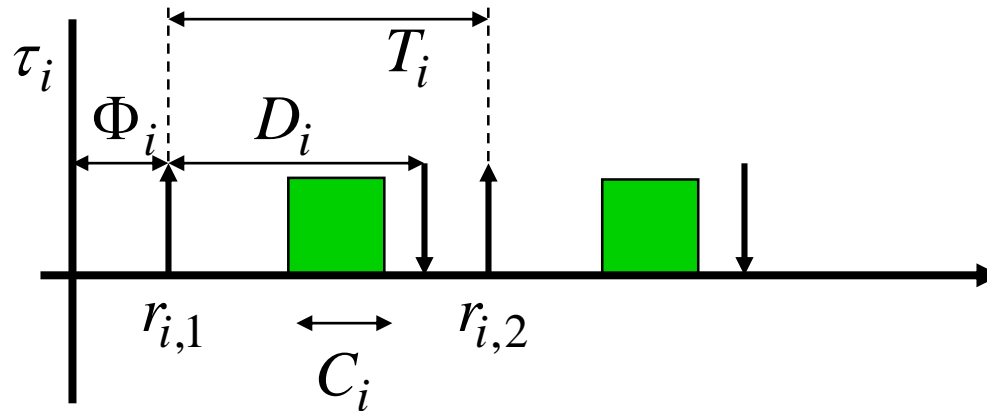

- *A set of periodic tasks* Γ :

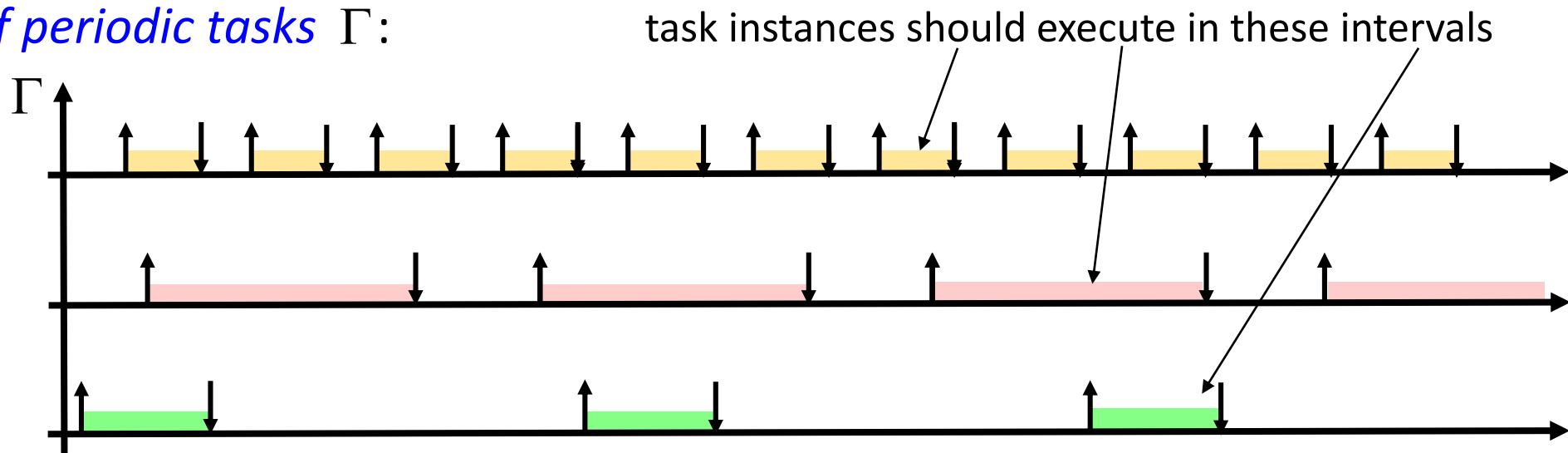

Time-Triggered Cyclic Executive Scheduling

- The following *hypotheses* are assumed on the tasks:
 - *The instances of a periodic task are regularly activated at a constant rate.* The interval T_i between two consecutive activations is called period. The release times satisfy

$$r_{i,j} = \Phi_i + (j-1)T_i$$

- *All instances have the same worst case execution time C_i .* The worst case execution time is also denoted as $WCET(i)$.
 - *All instances of a periodic task have the same relative deadline D_i .* Therefore, the absolute deadlines satisfy

$$d_{i,j} = \Phi_i + (j-1)T_i + D_i$$

Time-Triggered Cyclic Executive Scheduling

Example with 4 tasks:

- $\tau_1 : T_1 = 6, D_1 = 6, C_1 = 2$
 $\tau_3 : T_3 = 12, D_3 = 8, C_3 = 2$
- $P = 36, f = 4$

- $\tau_2 : T_2 = 9, D_2 = 9, C_2 = 2$
 $\tau_4 : T_4 = 18, D_4 = 10, C_1 = 4$

} requirement
 } schedule

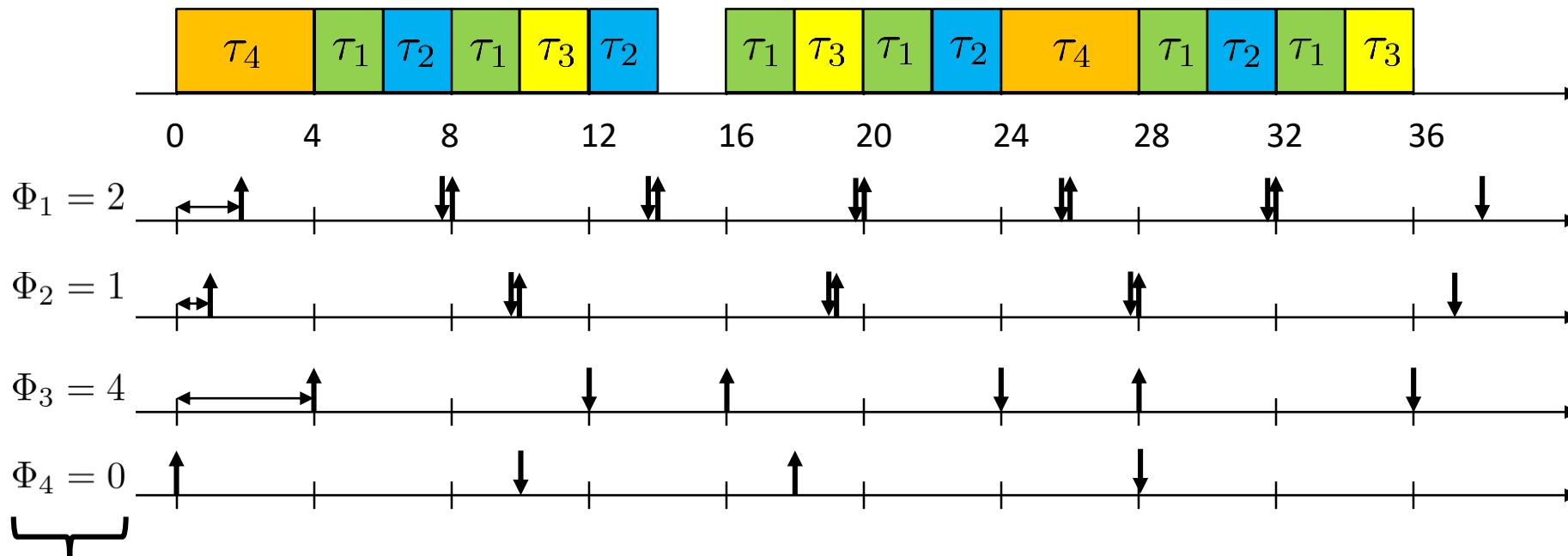

not given as part of the requirement

Time-Triggered Cyclic Executive Scheduling

Checking for correctness of schedule:

- f_{ij} denotes the number of the frame in which that instance j of task τ_i executes.
- Is P a common multiple of all periods T_i ?
- Is P a multiple of f ?
- Is the frame sufficiently long?

$$\sum_{\{i \mid f_{ij}=k\}} C_i \leq f \quad \forall 1 \leq k \leq \frac{P}{f}$$

- Determine offsets such that instances of tasks start after their release time:

$$\Phi_i = \min_{1 \leq j \leq P/T_i} \{(f_{ij} - 1)f - (j - 1)T_i\} \quad \forall \text{ tasks } \tau_i$$

- Are deadlines respected?

$$(j - 1)T_i + \Phi_i + D_i \geq f_{ij}f \quad \forall \text{ tasks } \tau_i, 1 \leq j \leq P/T_i$$

Generic Time-Triggered Scheduler

- In an *entirely time-triggered system*, the temporal control structure of all tasks is established a priori by off-line support-tools.
- This *temporal control structure is encoded in a Task-Descriptor List (TDL)* that contains the cyclic schedule for all activities of the node.
- This *schedule* considers the required precedence and mutual exclusion relationships among the tasks such that an explicit coordination of the tasks by the operating system at run time is not necessary.
- *The dispatcher is activated by a synchronized clock tick.* It looks at the TDL, and then performs the action that has been planned for this instant [Kopetz].

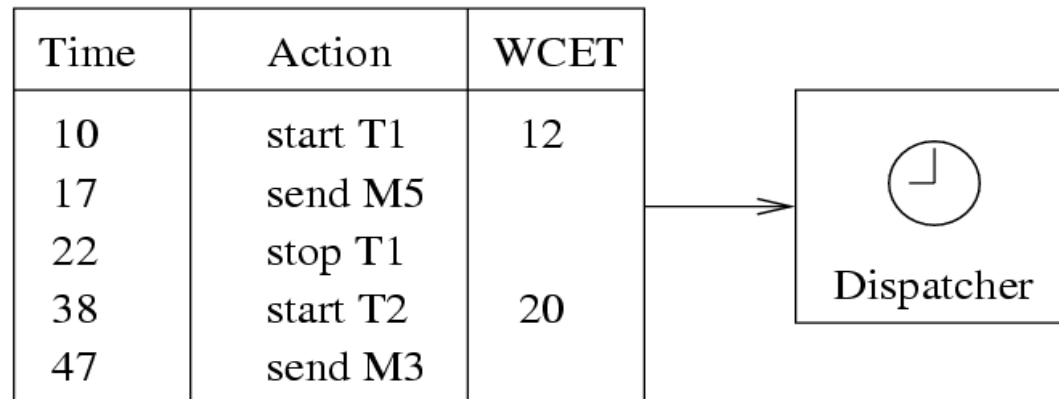

Simplified Time-Triggered Scheduler

main:

```
determine static schedule  $(t(k), T(k))$ , for  $k=0,1,\dots,n-1$ ;  
determine period of the schedule  $P$ ;  
set  $i=k=0$  initially; set the timer to expire at  $t(0)$ ;  
while (true) sleep();
```

usually done offline

Timer Interrupt:

```
 $k\_old := k$ ;  
 $i := i+1$ ;  $k := i \bmod n$ ;  
set the timer to expire at  $\lfloor i/n \rfloor * P + t(k)$ ;  
execute task  $T(k\_old)$ ;  
return;
```

set CPU to low power mode;
processing continues after interrupt

for example using a function pointer in C;
task returns after finishing.

k	$t(k)$	$T(k)$
0	0	T_1
1	3	T_2
2	7	T_1
3	8	T_3
4	12	T_2

$n=5, P = 16$

Summary Time-Triggered Scheduler

Properties:

- *deterministic schedule*; conceptually simple (static table); relatively easy to validate, test and certify
- *no problems* in using *shared resources*
- external communication only via *polling*
- *inflexible* as no adaptation to the environment
- serious *problems* if there are *long tasks*

Extensions:

- *allow interrupts* → be careful with shared resources and the WCET of tasks!!
- *allow preemptable* background tasks
- *check for task overruns* (execution time longer than WCET)

Event Triggered Systems

The schedule of tasks is determined by the occurrence of external or internal events:

- *dynamic and adaptive*: there are possible problems with respect to timing, the use of shared resources and buffer over- or underflow
- *guarantees* can be given either off-line (if bounds on the behavior of the environment are known) or during run-time

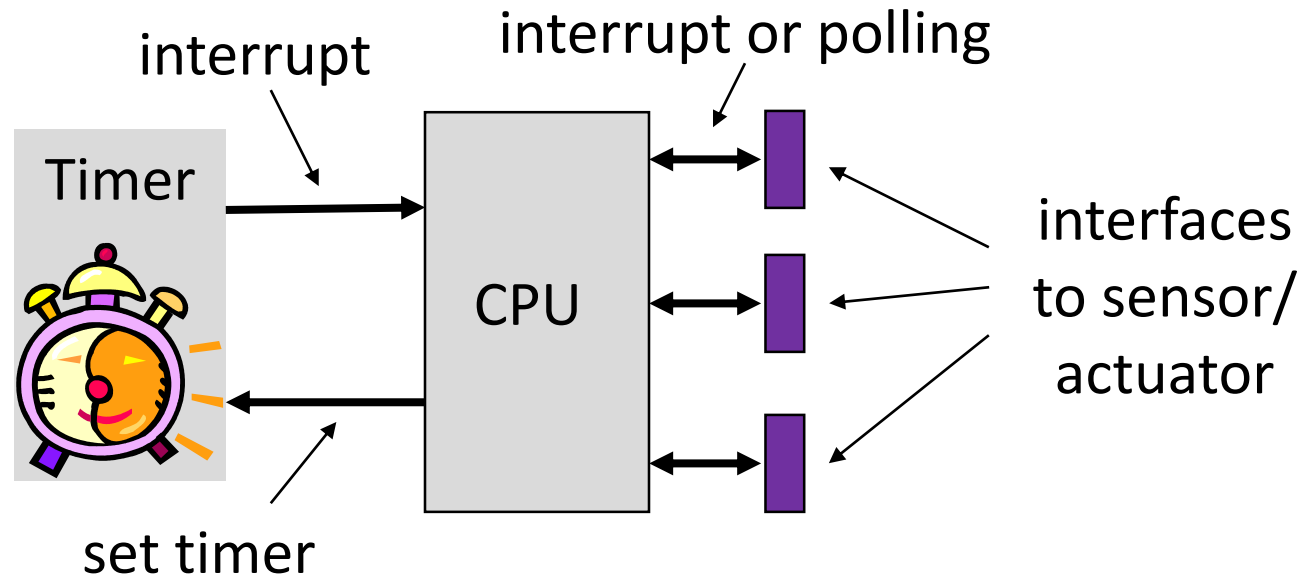

Non-Preemptive Event-Triggered Scheduling

Principle:

- To each event, there is associated a corresponding task that will be executed.
- Events are emitted by (a) external interrupts or (b) by tasks themselves.
- All events are collected in a single queue; depending on the queuing discipline, an event is chosen for execution, i.e., the corresponding task is executed.
- Tasks can not be preempted.

Extensions:

- A *background task* can run if the event queue is empty. It will be preempted by any event processing.
- *Timed events* are ready for execution only after a time interval elapsed. This enables periodic instantiations, for example.

Non-Preemptive Event-Triggered Scheduling

```
main:  
  while (true) {  
    if (event queue is empty) {  
      sleep();  
    } else {  
      extract event from event queue;  
      execute task corresponding to event;  
    }  
  }  
}
```

set the CPU to low power mode;
continue processing after interrupt

for example using a function pointer in C;
task returns after finishing.

```
Interrupt:  
  put event into event queue;  
  return;
```

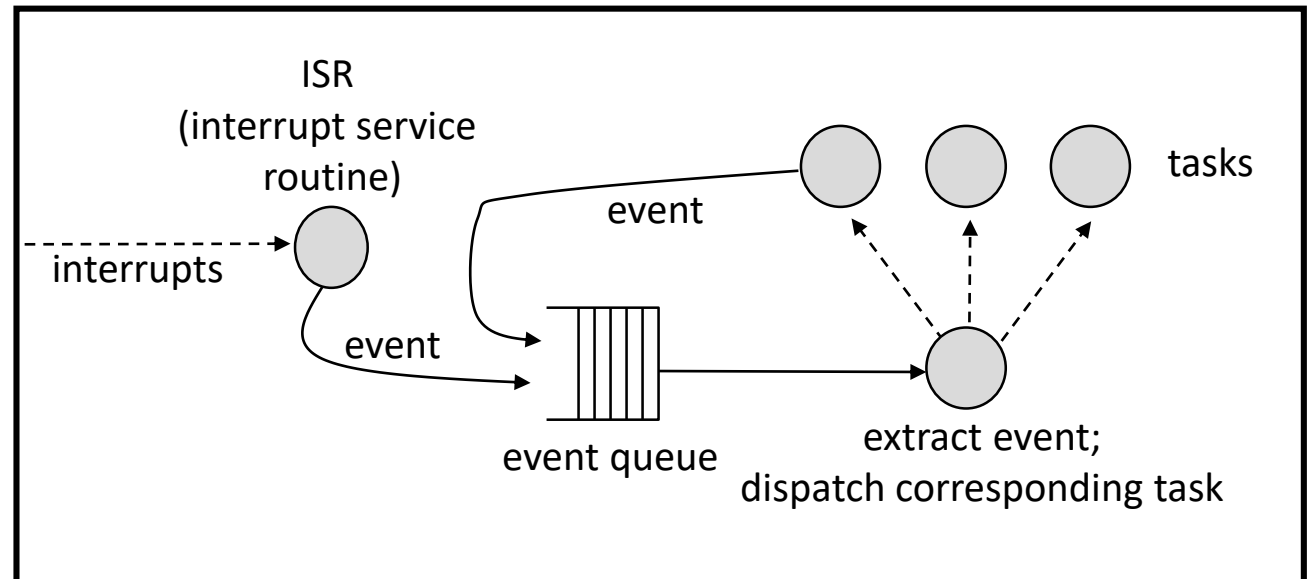

Non-Preemptive Event-Triggered Scheduling

Properties:

- *communication between tasks* does not lead to a simultaneous access to shared resources, but interrupts may cause problems as they preempt running tasks
- *buffer overflow* may happen if too many events are generated by the environment or by tasks
- *tasks with a long running time* prevent other tasks from running and may cause buffer overflow as no events are being processed during this time
 - partition tasks into smaller ones
 - but the local context must be stored

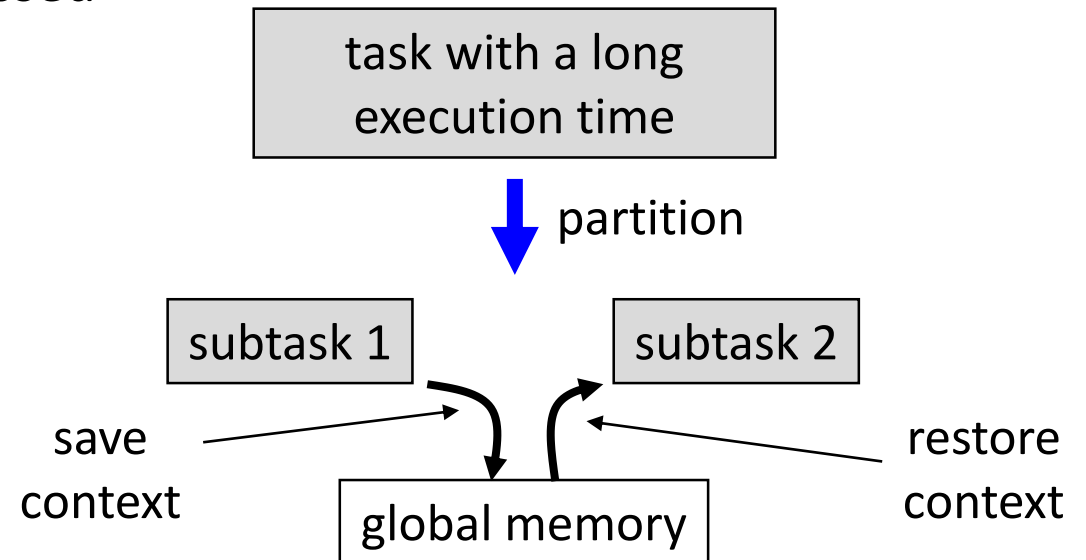

Preemptive Event-Triggered Scheduling – Stack Policy

- This case is similar to non-preemptive case, but *tasks can be preempted by others*; this resolves partly the problem of tasks with a long execution time.
- If *the order of preemption is restricted*, we can use the usual stack-based context mechanism of function calls. The context of a function contains the necessary state such as local variables and saved registers.

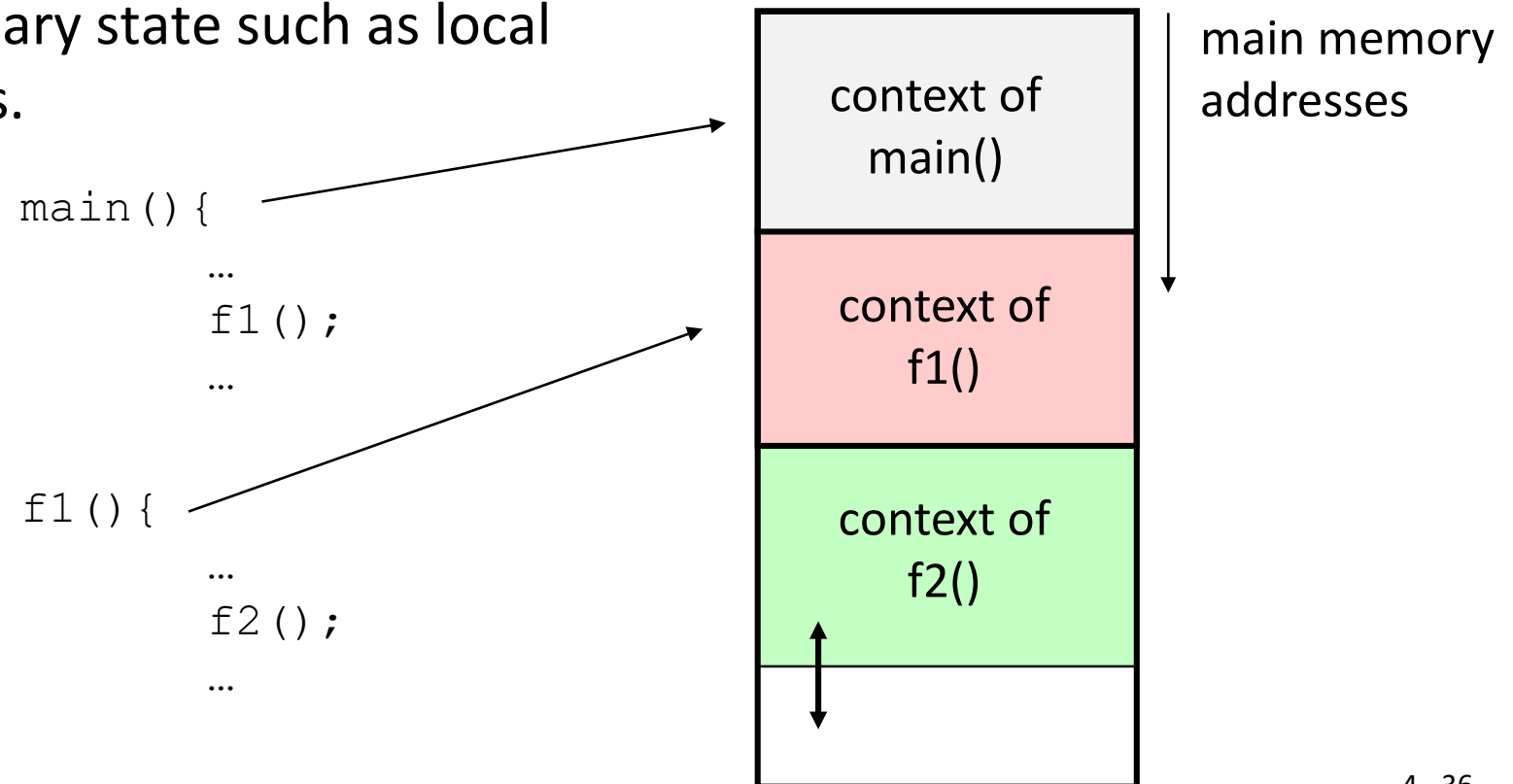

Preemptive Event-Triggered Scheduling – Stack Policy

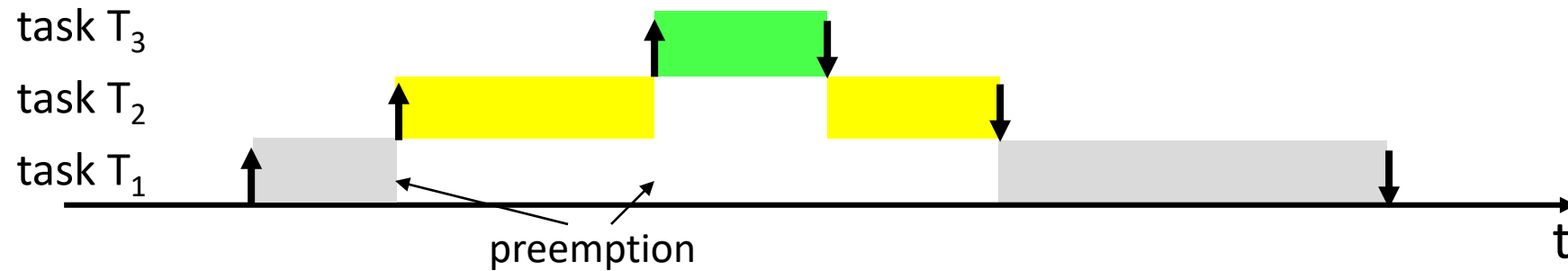

- *Tasks must finish in LIFO (last in first out) order* of their instantiation.
 - this restricts flexibility of the approach
 - it is not useful, if tasks wait some unknown time for external events, i.e., they are blocked
- *Shared resources* (communication between tasks!) *must be protected*, for example by disabling interrupts or by the use of semaphores.

Thread

- *A thread is a unique execution of a program.*
 - Several copies of such a “program” may run simultaneously or at different times.
 - Threads share the same processor and its peripherals.
- *A thread has its own local state.* This state consists mainly of:
 - register values;
 - memory stack (local variables);
 - program counter;
- *Several threads may have a shared state* consisting of global variables.

Threads and Memory Organization

- *Activation record* (also denoted as the thread context) contains the thread local state which includes registers and local data structures.
- *Context switch:*
 - current CPU context goes out
 - new CPU context goes in

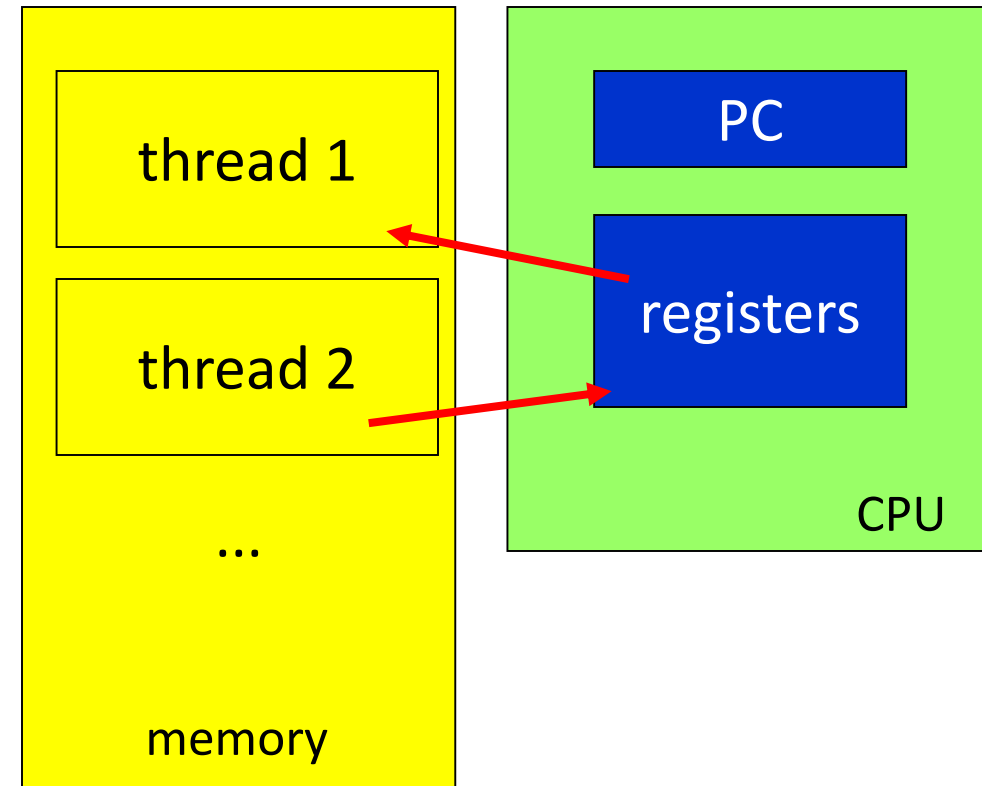

Co-operative Multitasking

- *Each thread allows a context switch to another thread* at a call to the `cswitch()` function.
 - This function is part of the underlying runtime system (operating system).
 - A *scheduler* within this runtime system chooses which thread will run next.
- **Advantages:**
 - predictable, where context switches can occur
 - less errors with use of shared resources if the switch locations are chosen carefully
- **Problems:**
 - programming errors can keep other threads out as a thread may never give up CPU
 - real-time behavior may be at risk if a thread runs too long before the next context switch is allowed

Example: Co-operative Multitasking

Thread 1

```
if (x > 2)
    sub1(y);
else
    sub2(y);
cswitch();
proca(a,b,c);
```

Thread 2

```
procd(r,s,t);
cswitch();
if (val1 == 3)
    abc(val2);
rst(val3);
```

Scheduler

```
save_state(current);
p = choose_process();
load_and_go(p);
```

Preemptive Multitasking

- *Most general form of multitasking:*

- The scheduler in the runtime system (operating system) controls when contexts switches take place.
- The scheduler also determines what thread runs next.

- *State diagram corresponding to each single thread:*

- **Run:** A thread enters this state as it starts executing on the processor
- **Ready:** State of threads that are ready to execute but cannot be executed because the processor is assigned to another thread.
- **Blocked:** A task enters this state when it waits for an event.

